

2. PAL DLW Option, Spare Parts and PM Kit

2.1. Spare Parts Order Information for PAL DLW-2 Option

note

Please note that this section of Spare Parts is intended for the PAL DLW-2 Option only. The Spare Parts for the previous version, PAL DLW Option, are listed below under point 2.2. The upgrade path from 'DLW' to 'DLW-2' is described under point 4.



| Part No.: | Description | Illustration |
|------------------------|--|---|
| DLW Pump Module | | |
| PAL DLWPump | PAL DLW Pump Kit (single module); incl. electrical connections; 24V. |  |
| PAL DiAspKit | Aspiration Tube Kit, consisting of: 1 pc. Tube PFA 1 pc. Glass Filter, 40 µm pore size 1 pc. Plug with feed through hole. |  |
| Cbl R4LX-1300 | Cable for PAL-xt Wash Station round connector, length 130 cm |  |
| PAL DLWPCB | PAL DLW Pump Control Module PCB Kit |  |
| PAL TubeDLW | PAL DLW Wash Station Tubing Kit, Consisting of: Tubing set, wire supports and connections. |  |

Table 1. Spare Parts PAL DLW-2 Option.

| Part No.: | Description | Illustration |
|-------------------------|---|---|
| DLW Wash Station | | |
| PAL DLWash | PAL DLW Wash Station Block, complete assembly (incl. centering plate). |  |
| PAL DLW Insert | PAL DLW Wash Station Insert Kit, consisting of: 2 pcs Inserts 1 pc. Waste Connector 5 pcs. Dummy Plugs |  |
| PAL TubeWaste | Tube Waste for Wash Station, length 2 m. |  |

Table 1 (cont'd.). Spare Parts PAL DLW-2 Option.

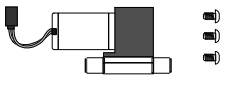
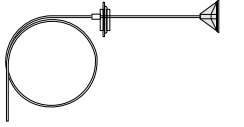
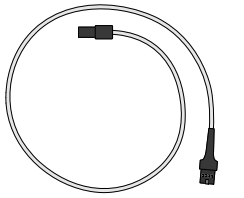

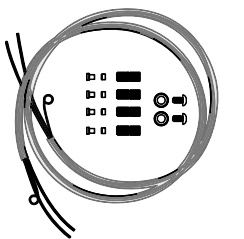
| Part No.: | Description | Illustration |
|------------------------------------|--|---|
| DLW Syringe | | |
| SyrC DLW100-R | CTC Syringe for PAL DLW Option, 100 µL gastight; Ø7.7 mm; Scale Length 60 mm; Thread ¼-28 UNF. Removable needle not included. |  |
| PLG DLW 100 | Replacement Plunger for Syringe SYRC DLW-R.; pkg of 10. |  |
| PAL DLWPlg | PAL DLW Plunger Holder |  |
| DLW Syringe Holder Assembly | | |
| PAL DLW-2Holder | PAL DLW-2 Syringe Holder Assembly; complete Assembly with Holding Loop (stainless steel) and 100 µL Syringe installed. |  |
| PAL DLW-2Holder-FEP | PAL DLW-2 Syringe Holder Assembly; complete Assembly with Holding Loop (FEP) and 100 µL Syringe installed. | |
| PAL DLW-2Loop | Kit PAL DLW-2 Holding Loop with Needle, Adapter mounted, including Retaining Nut. Holding Loop: stainless steel. |  |
| PAL DLWLoopKit | Kit PAL DLW-2 Holding Loop with Needle Adapter mounted, PAL DLW Needle incl. Retaining Nut and Flow Diverter. Holding Loop: FEP. |  |
| PAL DLW Manifold | PAL DLW Manifold Kit, complete, assembled. |  |
| PAL DLWAct | PAL DLW Actuator/Solenoid Kit; incl. screws, without cable. |  |

Table 1 (cont'd.). Spare Parts PAL DLW-2 Option.

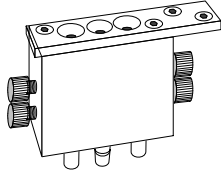
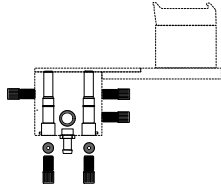
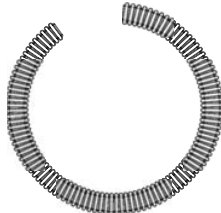
| Part No.: | Description | Illustration |
|-----------------|---|---|
| PAL DLW-2ActPCB | PAL DLW-2 Actuator Control PCB Kit; incl. cable and screw set. |  |
| PAL DLW Screw | Syringe Holder Fixation Screw, pkg of 1 |  |
| PAL DLW NdlTool | PAL DLW Needle Length Guide Tool, pkg of 1. |  |
| PAL DLW-2NHA | PAL DLW-2 Needle Holder Kit |  |

Table 1. Spare Parts PAL DLW-2 Option.

2.2. Spare Part Order Information for PAL DLW Option

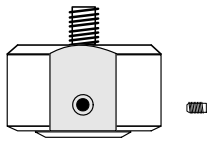
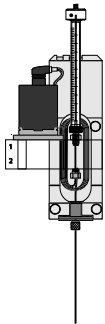
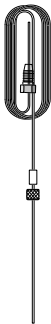
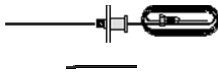
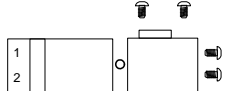
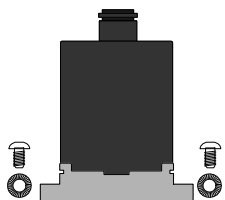
note

Please note that this section of Spare Parts is specific to the PAL DLW Option. The listing below shows only the spare parts which are specific to the 'DLW Option'. The other parts are either identical to the 'DLW-2 Option Spare Parts' or are backwards compatible. The upgrade path from 'DLW' to 'DLW-2' is described under point 4.

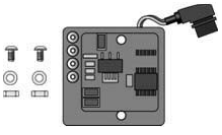
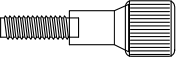
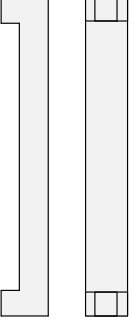
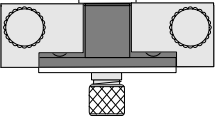
| Part No.: | Description | Illustration |
|------------------------------------|---|---|
| DLW Syringe | | |
| PAL DLWnDI | Needle Kit for PAL DLW Option, Gauge 22 PST 3, length 51 mm (3 pcs. per pack); incl. Needle Retaining Nut, Spring Washer and PTFE Seals. |  |
| PAL DLWnDI-C | Needle Kit for PAL DLW Option, Gauge 22 PST 3, length 51 mm. Needle coated with inorganic glass layer for inertness. (3 pcs. per pack); incl. Needle Retaining Nut, Spring Washer and PTFE Seals. |  |
| DLW Syringe Holder Assembly | | |
| PAL DLW Holder | <i>PAL DLW Syringe Holder Assembly; complete Assembly with Holding Loop (FEP) and 100 µL Syringe installed.</i> <i>'DLW' version not available as single spare part anymore. Select 'PAL DLW-2Holder-FEP'.</i> |  |
| PAL DLW-2Holder-FEP | PAL DLW-2 Syringe Holder Assembly; complete Assembly with Holding Loop (FEP) and 100 µL Syringe installed. (Replacement Kit for 'PALDLW Holder.') |  |

Table 2 (contd.). Spare Parts PAL DLW Option.



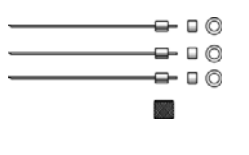
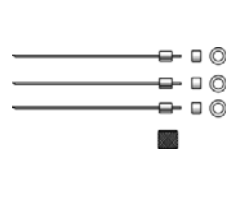
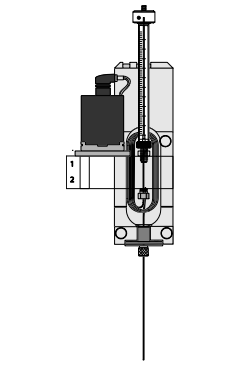
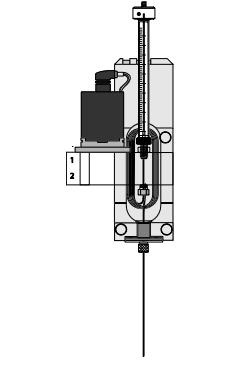
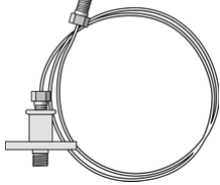
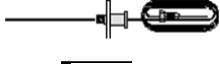
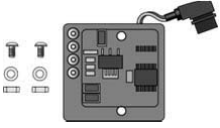

| Part No.: | Description | Illustration |
|----------------|---|---|
| PAL DLWLoop | Kit PAL DLW Holding Loop with Needle, Adapter mounted. |  |
| PAL DLWLoopKit | Kit PAL DLW-2 Holding Loop with Needle Adapter mounted, PAL DLW Needle incl. Retaining Nut and Flow Diverter. Loop: FEP. |  |
| PAL DLWFlwDiv | PAL DLW Flow Diverter Pkg of 1. |  |
| PAL DLWActPCB | PAL DLW Actuator Control PCB Kit; incl. cable and screw set. <i>'DLW' version not available as single spare part anymore. The 'DLW-2' version is not backwards compatible. Select 'Upgrade Holder', PNo.: PAL DLW-2UpgrdKit See point 3.4 'Upgrade Path' below.</i> |  |
| PAL DLWNHA | PAL DLW Needle Holder Kit <i>'DLW' version not available as single spare part anymore. The 'DLW-2' version is not backwards compatible. Select 'Upgrade Holder', PNo.: PAL DLW-2UpgrdKit See point 3.4 'Upgrade Path' below.</i> |  |

Table 2. Spare Parts PAL DLW Option.